

# Installation and Operational Instructions for EAS<sup>®</sup>-smartic<sup>®</sup> synchronous clutch Type 48\_\_5\_\_ Sizes 01 – 2

(B.4.17.1.GB)

**Please read these Operational Instructions carefully and follow them accordingly!**

Ignoring these Instructions may lead to malfunctions or to clutch failure, resulting in damage to other parts.

## Contents:

- Page 1:** - Contents  
- Safety and Guideline Signs  
- Safety Regulations
- Page 2:** - Illustrations Type 481\_\_5\_\_  
- Illustrations Type 484\_\_5\_\_
- Page 3:** - Illustrations Type 486\_\_5\_\_
- Page 4:** - Parts List
- Page 5:** - Table 1: Technical Data
- Page 6:** - Table 2: Screws Overview
- Page 7:** - Design  
- State of Delivery  
- Function  
- Installation of the Output Elements
- Page 8:** - Mounting onto the Shaft on Type 481
- Page 9:** - Mounting onto the Shaft on Type 484
- Page 10:** - Mounting onto the Shaft on Type 486
- Page 11:** - Permitted Shaft Misalignments  
- Shaft Alignment
- Page 12:** - Torque Adjustment  
- Cup Spring Layering  
- Changing the Torque  
- Table 3: Cup Spring Layering and Torque Ranges
- Page 13:** - Changing the Torque Adjustment Range by Changing the Cup Spring Layering
- Page 14:** - Limit Switch Installation  
- Maintenance  
- Disposal
- Page 15:** - General Malfunctions / Breakdowns
- Page 16:** - Malfunctions / Breakdowns Type 484.
- Page 17:** - Malfunctions / Breakdowns Type 484.
- Page 18:** - Malfunctions / Breakdowns Type 486.

## Safety and Guideline Signs

### CAUTION



Danger of injury to personnel and damage to machines.



**Please Observe!**  
Guidelines on important points.

## Safety Regulations

These Installation and Operational Instructions (I + O) are part of the clutch delivery. Please keep them handy and near to the clutch at all times.



It is forbidden to start use of the product until you have ensured that all applicable EU directives and directives for the machine or system into which the product has been installed have been fulfilled. At the time these Installation and Operational Instructions go to print, the EAS<sup>®</sup>-smartic<sup>®</sup> clutches accord with the known technical specifications and are operationally safe at the time of delivery. Without a conformity evaluation, this product is not suitable for use in areas where there is a high danger of explosion. This statement is based on the ATEX directive.

### CAUTION



- If the EAS<sup>®</sup>-smartic<sup>®</sup> clutches are modified.
- If the relevant standards for safety and / or installation conditions are ignored.

### **User-implemented Protective Measures**

- Cover all moving parts to protect against seizure, dust or foreign body impact.
- The clutch may not be put into operation without a limit switch unless mayr<sup>®</sup> has been contacted and has agreed otherwise.

**To prevent injury or damage, only professionals and specialists should work on the devices, following the relevant standards and directives. Please read the Installation and Operational Instructions carefully before installation and initial operation of the device.**

**These Safety Regulations are user hints only and may not be complete!**

# Installation and Operational Instructions for EAS<sup>®</sup>-smartic<sup>®</sup> synchronous clutch Type 48...5... Sizes 01 – 2

(B.4.17.1.GB)

## Type 481...\_...\_

Clamping ring hub with and without keyway

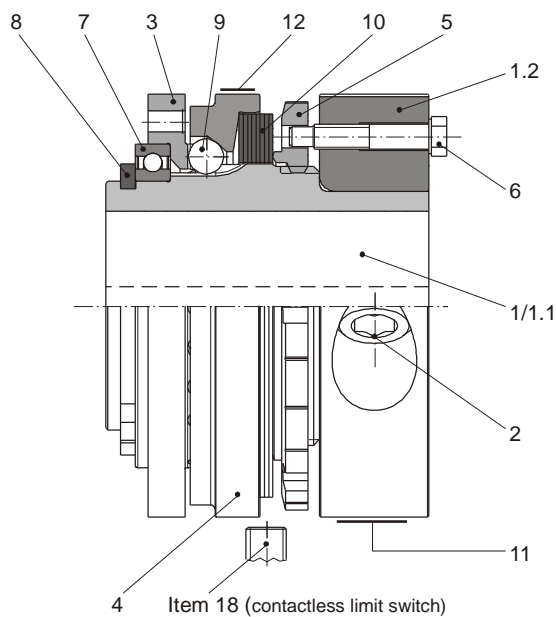

Hub key design

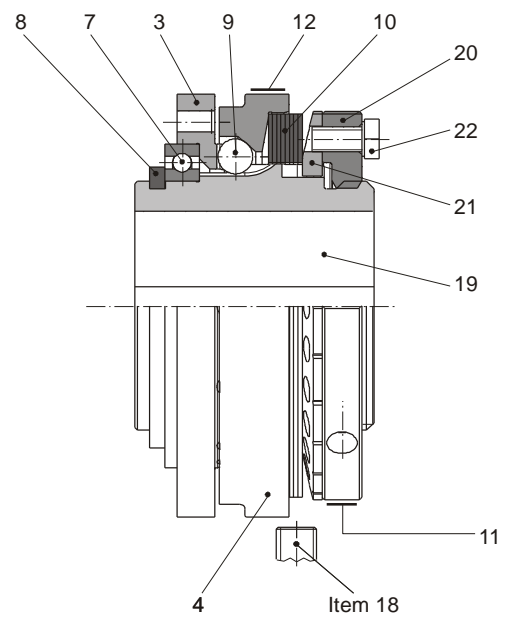
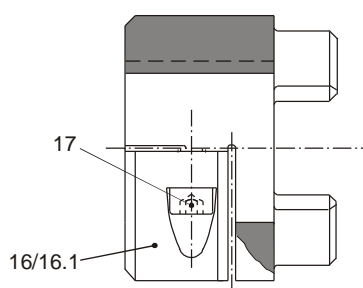

Fig. 1

## Type 484...\_...\_

Clamping hub  
with and without  
keyway



Clamping ring hub  
with and without  
keyway

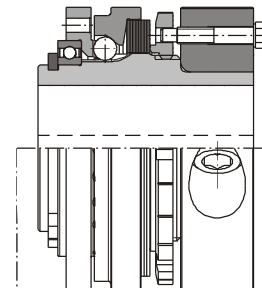

Hub  
key  
design

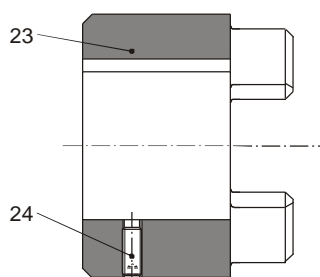

Hub  
key  
design

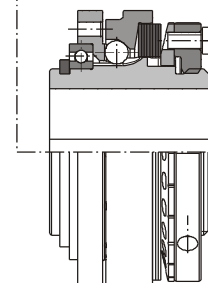

Fig. 2

# Installation and Operational Instructions for EAS<sup>®</sup>-smartic<sup>®</sup> synchronous clutch Type 48...5... Sizes 01 – 2

(B.4.17.1.GB)

Type 486... ..

Clamping hub  
with and without  
keyway  
Size 2

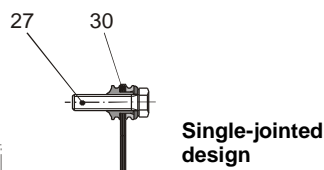
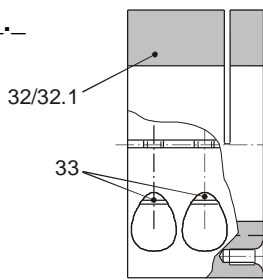

Single-jointed  
design

Hub  
key  
design  
Size 2

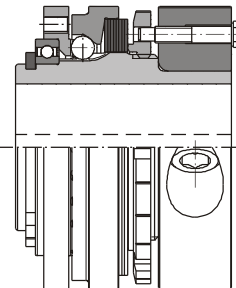
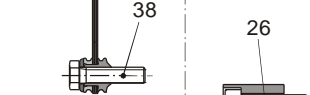
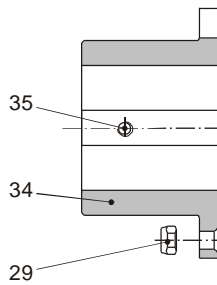

Clamping ring hub  
with and without  
keyway

Hub large  
keyway  
design  
Size 2

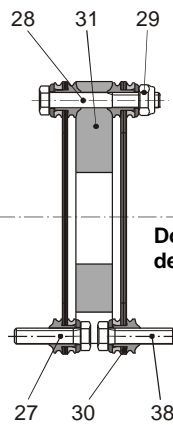
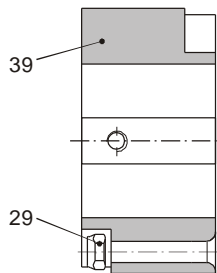

Double-jointed  
design

Flange  
Size 2

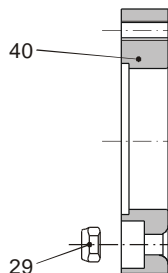

Single-jointed  
design

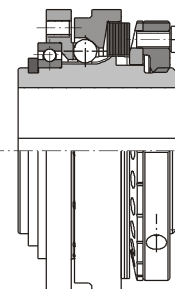

Hub  
key  
design

Clamping hub  
with and without  
keyway  
Sizes 01 to 1

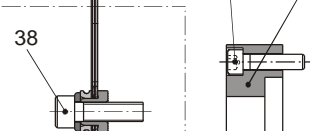
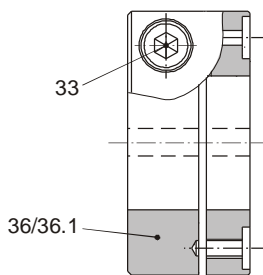

Single-jointed  
design

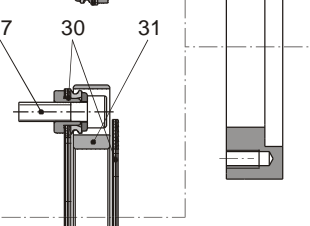

Double-jointed  
design

Fig. 3

# Installation and Operational Instructions for EAS<sup>®</sup>-smartic<sup>®</sup> synchronous clutch Type 48 \_ \_ 5 \_ Sizes 01 – 2

(B.4.17.1.GB)

## Parts List (Only use mayr<sup>®</sup> original parts)

Item	Name
1	Clamping ring hub
1.1	Clamping ring hub with keyway
1.2	Clamping ring
1.3	Spring pin (Fig. 15 / page 13)
2	Cap screw
3	Pressure flange
4	Thrust washer
5	Adjusting nut (for clamping ring hub design)
6	Hexagon head screw (for clamping ring hub design)
7	Deep groove ball bearing
8	Locking ring
9	Steel ball
10	Cup spring (layering dependent on Type)
11	Adjustment Table
12	Type tag
13	Connection flange Type 484.
14	Cap screw
15	Flexible elastomeric element
16	Clamping hub Type 484.
16.1	Clamping hub Type 484. with keyway
17	Cap screw
18	Limit switch
19	Hub (key design)

Item	Name
20	Adjusting nut (for key design)
21	Locking ring (for key design)
22	Hexagon head screw (for key design)
23	Hub Type 484. (key design)
24	Set screw
25	Connection flange Type 486.
26	Cap screw
27	Screw
28	Hexagon head screw
29	Hexagon nut
30	Disk pack assembly
31	Connection plate
32	Clamping hub Type 486. (Size 2)
32.1	Clamping hub Type 486. with keyway (Size 2)
33	Cap screw
34	Hub Type 486. (key design / Size 2)
35	Set screw
36	Clamping hub Type 486. (Sizes 01 to 1)
36.1	Clamping hub Type 486. with keyway (Sizes 01 to 1)
37	Cap screw
38	Screw
39	Hub, large (key design)
40	Flange



The limit switch Item 18 is not included in the standard delivery.

# Installation and Operational Instructions for EAS<sup>®</sup>-smartic<sup>®</sup> synchronous clutch Type 48\_.\_5\_ Sizes 01 – 2

(B.4.17.1.GB)

Table 1: Technical Data

Size	01	0	1	2
Thread in the pressure flange (Item 3)	8 x M4	8 x M4	8 x M5	8 x M6
Max. screw-in depth $b_{max}$ in the pressure flange (Item 3) [mm]	6	6,5	7	9,5
Connection dimension "a" +0,1 [mm]	2,5	2,5	2,5	3
Connection dimension "e" [mm]	42 h5	52 h5	65 h5	78 h5
Tightening torque (Item 2) [Nm]	40	40	83	140
Tightening torque (Item 14) <sup>1)</sup> [Nm]	4	4,5	9	16
Tightening torque (Item 17) Types 484.2_5_ to 484.7_5_ [Nm]	10	25	25	120
Type 484.8_5_ [Nm]	17	40	40	140
Tightening torque (Item 26) <sup>1)</sup> [Nm]	4	4,5	9	16
Tightening torque (Items 27 / 28 / 38) [Nm]	8,5	8,5	8,5	8,5
Tightening torque (Item 33) [Nm]	13	33	33	42
Tightening torque (35) up to bore $\varnothing$ 22 more than bore $\varnothing$ 22 [Nm]				2 4,1
Tightening torque (37) [Nm]	8,5	8,5	8,5	-
Axial forces [N]	400	500	800	1200
Radial forces [N]	400	500	800	1200
Transverse force torques <sup>2)</sup> [Nm]	3	5	10	15
Distance dimension "E" (see Figs. 5 and 6) [mm]	18	20	24	28
Distance dimension "U <sub>1</sub> " (see Figs. 7 and 8) [mm]	14,7	15,5	15,8	26,4
Distance dimension "S" (see Fig. 9) [mm]	2,6	3	2,9	7,2
<b>Permitted shaft misalignments Type 484_._5_</b>				
Radial misalignment $\Delta K_r$ 92 Sh A [mm]	0,14	0,15	0,17	0,21
98 Sh A [mm]	0,10	0,11	0,12	0,16
Axial displacement $\Delta K_a$ [mm]	1,4	1,5	1,8	2,1
Angular misalignment $\Delta K_w$ 92 Sh A [°]	1,0	1,0	1,0	1,0
98 Sh A [°]	0,9	0,9	0,9	0,9
<b>Permitted shaft misalignments Type 486_._5.0 (Double-jointed coupling)</b>				
Radial misalignment $\Delta K_r$ [mm]	0,15	0,2	0,2	0,3
Axial displacement $\Delta K_a$ [mm]	0,7	0,9	1,1	1,3
Angular misalignment $\Delta K_w$ [°]	2,0	2,0	2,0	2,0
<b>Permitted shaft misalignments Type 486_._5.8 (Single-jointed coupling)</b>				
Radial misalignment $\Delta K_r$ [mm]	-	-	-	-
Axial displacement $\Delta K_a$ [mm]	0,35	0,45	0,55	0,65
Angular misalignment $\Delta K_w$ [°]	1,0	1,0	1,0	1,0

<sup>1)</sup> Secure Items 14 and 26 wit Loctite 243.

<sup>2)</sup> Torques, which put strain on the deep groove ball bearing due to the non-centric axial forces having an effect on the pressure flange.

# Installation and Operational Instructions for EAS<sup>®</sup>-smartic<sup>®</sup> synchronous clutch Type 48 \_ . \_ 5. \_ Sizes 01 – 2

(B.4.17.1.GB)

**Table 2: Screws Overview (dependent on Type or hub connection)**

Item	Design	Size 01	Size 0	Size 1	Size 2
2	with hub Items 1 / 1.1	1x cap screw M8 x 25 DIN EN ISO 4762 12.9	1x cap screw M8 x 25 DIN EN ISO 4762 12.9	1x cap screw M10 x 30 DIN EN ISO 4762 12.9	1x cap screw M12 x 35 DIN EN ISO 4762 12.9
6	with hub Items 1 / 1.1	1x hexagon head screw M4 x 24,2 SO (DIN EN ISO 4014) 8.8	1x hexagon head screw M4 x 24,2 SO (DIN EN ISO 4014) 8.8	1x hexagon head screw M5 x 28 SO (DIN EN ISO 4014) 8.8	1x hexagon head screw M6 x 31,5 SO (DIN EN ISO 4014) 8.8
14	Type 484. _ . 5. _	8x cap screw M4 x 16 DIN EN ISO 4762 12.9	8x cap screw M4 x 16 DIN EN ISO 4762 12.9	8x cap screw M5 x 18 DIN EN ISO 4762 12.9	8x cap screw M6 x 22 DIN EN ISO 4762 12.9
17	with hub Items 16 / 16.1	1x cap screw M6 x 20 DIN EN ISO 4762 8.8	1x cap screw M8 x 25 DIN EN ISO 4762 8.8	1x cap screw M8 x 30 DIN EN ISO 4762 8.8	1x cap screw M12 x 35 DIN EN ISO 4762 12.9
22	with hub Item 19	1x hexagon head screw M3 x 8 DIN EN ISO 4017 8.8	1x hexagon head screw M4 x 10 DIN EN ISO 4017 8.8	1x hexagon head screw M5 x 10 DIN EN ISO 4017 8.8	1x hexagon head screw M5 x 12 DIN EN ISO 4017 8.8
26	Type 486. _ . 5. _	4x cap screw M4 x 16 DIN EN ISO 4762 12.9	8x cap screw M4 x 16 DIN EN ISO 4762 12.9	6x cap screw M5 x 20 DIN EN ISO 4762 12.9	6x cap screw M6 x 20 DIN EN ISO 4762 12.9
27	with hub Items 32 / 32.1 / 34 / 36 / 36.1 on double-jointed design	2x cap screw M5 x 16 DIN EN ISO 4762 10.9	2x cap screw M5 x 18 DIN EN ISO 4762 12.9	3x cap screw M5 x 20 DIN EN ISO 4762 12.9	3x cap screw M5 x 20 DIN EN ISO 4017 10.9
	with hub Items 32 / 32.1 / 34 / 36 / 36.1 on single-jointed design	2x cap screw M5 x 16 DIN EN ISO 4762 10.9	2x cap screw M5 x 18 DIN EN ISO 4762 12.9	3x hexagon head screw M5 x 16 DIN EN ISO 4017 10.9	3x cap screw M5 x 20 DIN EN ISO 4017 10.9
	with hub Item 39	---	---	---	3x hexagon head screw M5 x 50 DIN EN ISO 4014 10.9
	with flange Item 40	---	---	---	3x hexagon head screw M5 x 23 DIN EN ISO 4017 10.9
28	Type 486. _ . 5. 0	---	---	---	3x hexagon head screw M5 x 35 DIN EN ISO 4014 10.9
33	with hub Items 32 / 32.1 / 36 / 36.1	1x cap screw M6 x 20 DIN EN ISO 4762 12.9	1x cap screw M8 x 25 DIN EN ISO 4762 12.9	1x cap screw M8 x 30 DIN EN ISO 4762 12.9	2x cap screw M8 x 25 DIN EN ISO 4762 12.9
37	Type 486. _ . 5. 0	4x cap screw M5 x 16 DIN EN ISO 4762 10.9	4x cap screw M5 x 16 DIN EN ISO 4762 12.9	3x hexagon head screw M5 x 16 DIN EN ISO 4017 10.9 + 3x cap screw M5 x 16 DIN EN ISO 4762 12.9	---
38	Type 486. _ . 5. _	2x cap screw M5 x 16 DIN EN ISO 4762 10.9	2x cap screw M5 x 18 DIN EN ISO 4762 12.9	3x cap screw M5 x 16 DIN EN ISO 4762 12.9	3x hexagon head screw M5 x 23 DIN EN ISO 4017 10.9

# Installation and Operational Instructions for EAS<sup>®</sup>-smartic<sup>®</sup> synchronous clutch Type 48...5... Sizes 01 – 2

(B.4.17.1.GB)

## Design

The EAS<sup>®</sup>-smartic<sup>®</sup> clutch is designed as a mechanical disengaging overload clutch according to the ball detent principle.

## State of Delivery

The EAS<sup>®</sup>-smartic<sup>®</sup> clutch is manufacturer-assembled ready for installation.

If no particular torque adjustment is requested customer-side, the EAS<sup>®</sup>-smartic<sup>®</sup> clutch will always be pre-set to approximately 80 % of the maximum torque.

The reference marking on the adjusting nut (5) or on the locking ring (21) and the torque specification on the Adjustment Table (11) directly show the set value.

The hexagon head screw (6/22) is not secured with Loctite on a pre-set clutch.

Before initial operation of the clutch, please secure the locking screw (6/22) with Loctite 243.

Please check the state of delivery immediately according to the Parts List!

mayr<sup>®</sup> will take no responsibility for belated complaints.

Please report transport damage immediately to the deliverer.

Please report incomplete delivery and obvious defects to the manufacturer.

## Function

### Function in Normal Operation

The EAS<sup>®</sup>-smartic<sup>®</sup> clutch Type 481. transmits the torque from the input shaft onto the output element, which can be mounted onto the ball bearing supported pressure flange (3) of the clutch. The torque is transmitted backlash-free over the entire service lifetime of the clutch.

The EAS<sup>®</sup>-smartic<sup>®</sup> Types 484. and 486. connect two shafts and compensate for shaft misalignments.

### Function on Overload

If the set limit torque is exceeded, the clutch disengages. The torque drops immediately.

The residual torque is approx. 5 - 20 % of the set torque (at approx. 1500 rpm).

Therefore, the EAS<sup>®</sup>-smartic<sup>®</sup> clutch is not load-holding.

An installed limit switch (Item 18 / not included in delivery) registers the disengagement movement and switches off the drive.

Once the cause of malfunction has been removed, the clutch is automatically ready for operation after having reached the synchronous position:

**Re-engagement after 360°.**

## Installation of the Output Elements (Fig. 4)

The output elements are centred on the deep groove ball bearing (7) (tolerance H7/h5) and screwed together with the pressure flange (3).

Please use **screws with a strength class of 12.9** with the corresponding tightening torques acc. Table 1 (tightening torque Item 14) for screwing onto the pressure flange (3).

The output element must be made of a material with a minimum tensile strength of approx. 600 N/mm<sup>2</sup>.

Please contact the manufacturers if this is not the case.

If the resulting radial force from the output element is anywhere near the centre of the ball bearing, an additional bearing for the output element is not necessary.

No appreciable axial forces should be transmitted from the output element onto the clutch pressure flange (3).

Output elements with a very small diameter can be screwed together with the clutch pressure flange (3) via a customer-side intermediate flange.

Ball bearings, needle bearings or bearing bushings are suitable as bearings for the output element, depending on the installation situation and the installation space.

Please make sure that the output element bearing is designed as a location bearing (Fig. 4).

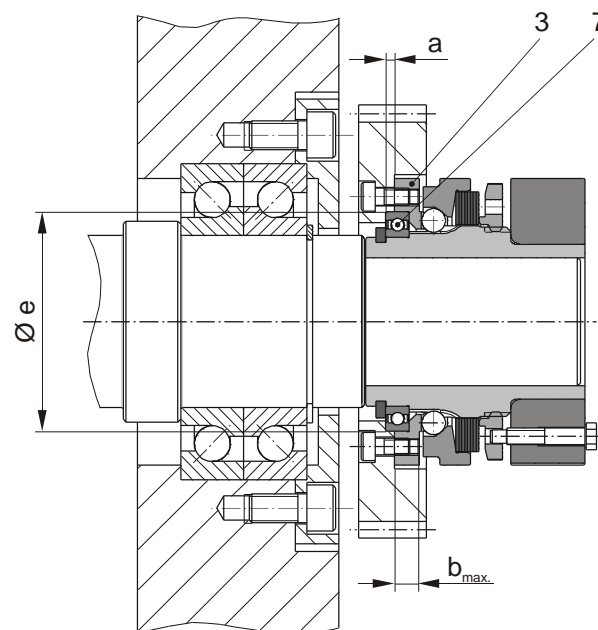

Fig. 4



The radial forces, axial forces or transverse force torques, which are introduced into the clutch bearing must not exceed the permitted values acc. Table 1.



Please observe the connection dimensions "a" and "e" for the output elements as well as the maximum permitted screw-in depth "b<sub>max</sub>" in the pressure flange (3); see Fig. 4 and Table 1 on page 5.

# Installation and Operational Instructions for EAS<sup>®</sup>-smartic<sup>®</sup> synchronous clutch Type 48\_.\_5\_.\_ Sizes 01 – 2

(B.4.17.1.GB)

## Mounting onto the Shaft

### General Shaft Requirements:

- Tolerance: up to  $\varnothing 38$  h6.  
from  $\varnothing 38$  h6 on clamping ring hubs  
from  $\varnothing 38$  k6 on clamping hubs
- Surface: finely turned or ground  
( $R_a = 0,8 \mu\text{m}$ )
- Material: yield point  
min.  $350 \text{ N/mm}^2$ ,  
e.g. St60, St70, C45, C60.

### 1. EAS<sup>®</sup>-smartic<sup>®</sup> flange design without shaft coupling

#### 1.1 Clamping ring hub design Type 481\_35.0:

- The shafts must be solid shafts without a keyway.
- Degrease or remove preservation layers on the shafts and bores before installing the clutch.  
**Greasy or oily bores or shafts do not transmit the torque  $T_R$  specified on order.**
- Mount the clutch onto the shaft end and bring it into the correct position.
- Tighten the clamping screw (2) using a torque wrench to the torque stated in Table 1.

#### 1.2 Key design Type 481\_25.0:

- Mount the clutch onto the shaft end and bring it into the correct position.
- On the EAS<sup>®</sup>-smartic<sup>®</sup> with keyway, the clutch must be secured axially after mounting onto the shaft, e.g. using a press cover and a screw screwed into the shaft threaded centre hole.

#### 1.3 Clamping ring hub design with keyway Type 481\_45.0:

- Degrease or remove preservation layers on the shafts and bores before installing the clutch.  
**Greasy or oily bores or shafts do not transmit the torque  $T_R$  specified on order.**
- Mount the clutch onto the shaft end and bring it into the correct position.
- Tighten the clamping screw (2) using a torque wrench to the torque stated in Table 1.



## 2. EAS<sup>®</sup>-smartic<sup>®</sup> dual-shaft connection with elastomer coupling ROBA<sup>®</sup>-ES

### General:

The elastomer coupling used is backlash-free and requires a certain axial installation force for joining. The amount of force required can be reduced by lightly greasing the elastomeric element (15).



- Only use PU - compatible lubricants (e.g. Vaseline)!
- After joining both coupling hubs, do not place axial pressure on the elastomeric element (15).
- Please observe the distance dimension "E" acc. Figs. 5/6 and Table 1!

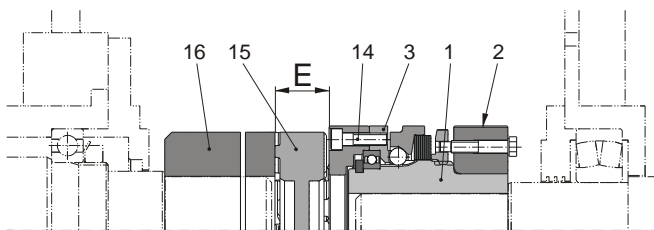

**Fig. 5**  
Clamping (ring) hub design Type 484...35...

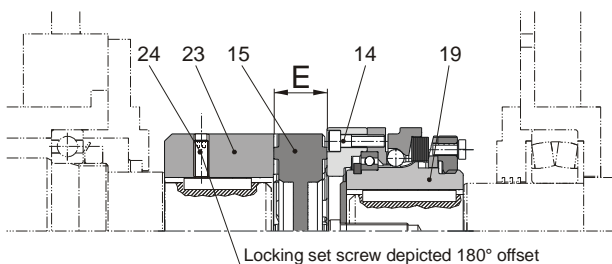

**Fig. 6**  
Key design Type 484...25...

### 2.1 Clamping (ring) hub design Type 484...35...:

- Install the overload clutch side as described in section 1.1.
- Degrease or remove preservation layers on the shafts and bores before installing the elastomer coupling.
- The clamping hub (16) must be completely relaxed before installation; if necessary loosen the screw (17) by several thread turns.
- Mount the elastomer coupling hub (16) onto the shaft end and bring it into the correct position.
- Tighten the clamping screw (17) using a torque wrench to the torque stated in Table 1.
- Joining the two clutch hubs:  
Due to the pre-tensioning of the flexible elastomeric element (15), an axial installation force is required for joining both clutch hubs (1 and 16). The amount of force required can be reduced by lightly greasing the elastomeric element (15).

### 2.2 Key design Type 484...25...:

- Install the overload clutch side as described in section 1.2.
- Mount the elastomer coupling hub onto the shaft end and bring it into the correct position.
- The elastomer coupling hub (23) must be secured axially onto the shaft, e.g. using a set screw (Item 24, see Fig. 6).
- Joining both clutch hubs:  
Due to the pre-tensioning of the flexible elastomeric element (15), an axial installation force is required for joining both clutch hubs (19 and 23). The amount of force required can be reduced by lightly greasing the elastomeric element (15).

### 2.3 Clamping (ring) hub design with keyway Type 484...45...:

- Install the overload clutch side as described in section 1.3.
- Degrease or remove preservation layers on the shafts and bores before installing the elastomer coupling.
- The clamping hub (16.1) must be completely relaxed before installation; if necessary loosen the screw (17) by several thread turns.
- Mount the elastomer coupling hub (16.1) onto the shaft end and bring it into the correct position.
- Tighten the clamping screw (17) using a torque wrench to the torque stated in Table 1.
- Joining both clutch hubs:  
Due to the pre-tensioning of the flexible elastomeric element (15), an axial installation force is required for joining both clutch hubs (1 and 16.1). The amount of force required can be reduced by lightly greasing the elastomeric element (15).

# Installation and Operational Instructions for EAS<sup>®</sup>-smartic<sup>®</sup> synchronous clutch Type 48...5... Sizes 01 – 2

(B.4.17.1.GB)

## 3. EAS<sup>®</sup>-smartic<sup>®</sup> dual-shaft connection with torsionally rigid shaft coupling ROBA<sup>®</sup>-DS

### General:

On clamping hubs (36/36.1), the clamping screw (33) is lightly greased manufacturer-side in the thread area. If the grease layer is washed off, the customer must re-grease the appropriate parts. For greasing, please use NLGI Class 2 grease with a basic oil viscosity of 220 mm<sup>2</sup>/s at 40 °C, e.g. Mobilgrease XHP222.



After joining both coupling halves, please test and keep to distance dimensions "U<sub>1</sub>" or "S" acc. Figs. 7 / 8 / 9 and Table 1!

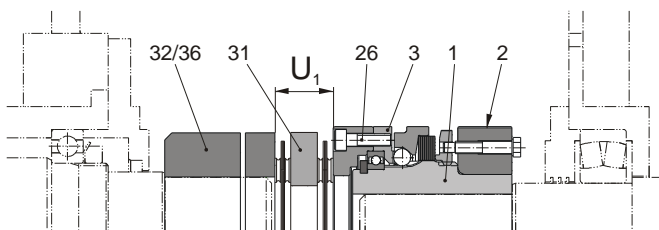

**Fig. 7**  
Clamping (ring) hub design Type 486...35.0

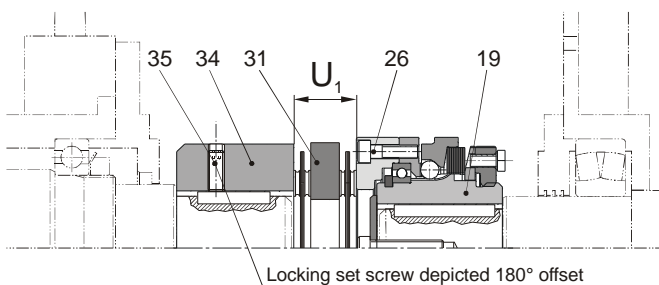

**Fig. 8**  
Key design Type 486...25.0 (Size 2)

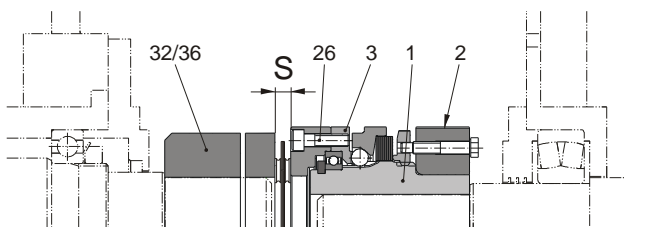

**Fig. 9**  
Type 486...5.8 (Single-jointed design)

### 3.1 EAS<sup>®</sup>-smartic<sup>®</sup> Clamping (ring) hub design Type 486...35.0:

- On clamping (ring) hubs, the torque is transmitted via frictional locking, which means that the hub bores and shafts must be completely grease-free during installation. **Greasy or oily bores or shafts do not transmit the maximum clutch torque.**
- The shafts must not have a keyway.
- The clamping hubs (32/36) must be completely relaxed before installation; if necessary the screws (33) must be loosened by several thread turns.
- Mount the first clutch hub of the entire clutch onto the respective shaft and bring it into the correct position.
- Tighten the clamping screw(s) of the first clutch hub using a torque wrench to the torque stated in Table 1.
- Mount the second clutch hub of the entire clutch onto the respective shaft and bring it into the correct position.
- Tighten the clamping screw(s) of the second clutch hub using a torque wrench to the torque stated in Table 1.

### 3.2 EAS<sup>®</sup>-smartic<sup>®</sup> key design Type 486...25.0:

- Mount the ROBA<sup>®</sup>-DS-side clutch hub (34/36.1) of the entire clutch onto the respective shaft and bring it into the correct position.
- Tighten the clamping screw (33) or the radial set screw (35) of this first clutch hub using a torque wrench to the torque stated in Table 1.
- Mount the second EAS<sup>®</sup>-side clutch hub of the entire clutch onto the respective shaft.

### 3.3 EAS<sup>®</sup>-smartic<sup>®</sup> Clamping (ring) hub design with keyway Type 486...45.0:

- The clamping hubs (32.1/36.1) must be completely relaxed before installation; if necessary the screws (33) must be loosened by several thread turns.
- Degrease or remove preservation layers on the shafts and bores before installing the clutch.
- Mount the first clutch hub of the entire clutch onto the respective shaft and bring it into the correct position.
- Tighten the clamping screw(s) of the first clutch hub using a torque wrench to the torque stated in Table 1.
- Mount the second clutch hub of the entire clutch onto the respective shaft and bring it into the correct position.
- Tighten the clamping screw(s) of the second clutch hub using a torque wrench to the torque stated in Table 1.

# Installation and Operational Instructions for EAS<sup>®</sup>-smartic<sup>®</sup> synchronous clutch Type 48\_\_ 5.0 Sizes 01 – 2

(B.4.17.1.GB)

## Permitted Shaft Misalignments

EAS<sup>®</sup>-smartic<sup>®</sup> clutch Types 484.\_\_ 5.0 and 486.\_\_ 5.0 (double-jointed coupling) compensate for angular, axial and radial shaft misalignments (Figs. 10 and 11) without losing their backlash-free function.

EAS<sup>®</sup>-smartic<sup>®</sup> clutches Type 486.\_\_ 5.8 (single-jointed coupling) only compensate for angular and axial shaft misalignments.

However, the permitted shaft misalignments indicated in Table 1 must not simultaneously reach their maximum value. If more than one kind of misalignment takes place simultaneously, they influence each other.

This means that the permitted misalignment values are dependent on one another, see Fig. 13.

The sum total of the actual misalignments in percent of the maximum value must not exceed 100 %.

The misalignment values stated in Table 1 refer to clutch operation at nominal torque, an ambient temperature of +30 °C and an operating speed of 1500 rpm.

In other or more extreme clutch operating conditions, please contact the manufacturers.

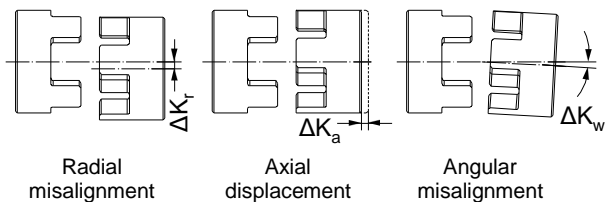

**Fig. 10**  
Type 484.\_\_ 5.0

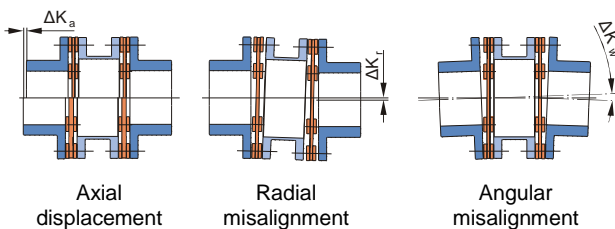

**Fig. 11**  
Type 486.\_\_ 5.0 (double-jointed coupling)

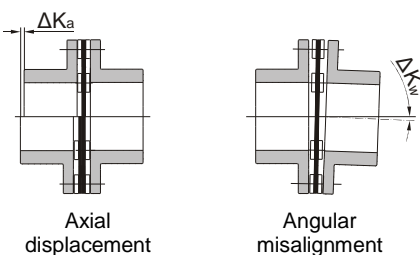

**Fig. 12**  
Type 486.\_\_ 5.8 (single-jointed coupling)

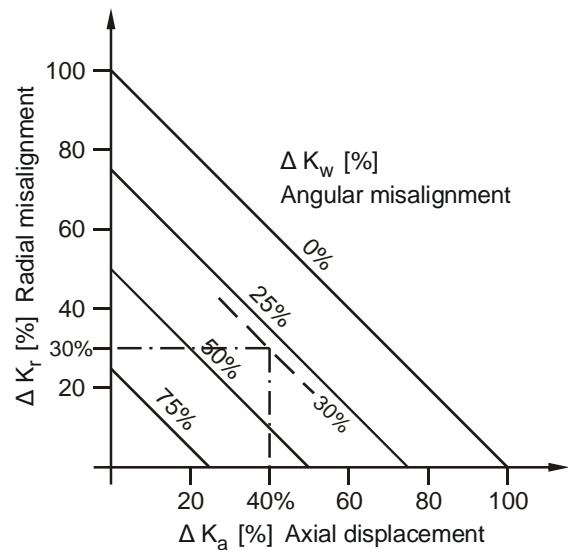

**Fig. 13**

### Example (Size 0 / Type 486.\_\_ 5.0):

Axial displacement occurrence  $\Delta K_a = 0,36$  mm equals 40 % of the permitted maximum value  $\Delta K_a = 0,9$  mm.

Angular misalignment occurrence  $\Delta K_w = 0,6^\circ$ , equals 30 % of the permitted maximum value  $\Delta K_w = 2,0^\circ$ .

=> Permitted radial misalignment  $K_r = 30$  % of the maximum value  $\Delta K_r = 0,2$  mm =>  $\Delta K_r = 0,06$  mm

## Shaft Alignment

Exact alignment of the shafts reduces the load on the shaft bearings and increases the clutch lifetime substantially. In very high-speed drives, we recommend alignment using a suitable alignment device (e.g. a laser). However, in most of the applications, shaft alignment using a straight edge in two levels vertical to each other is sufficient.

# Installation and Operational Instructions for EAS®-smartic® synchronous clutch Type 48\_\_5\_\_ Sizes 01 – 2

(B.4.17.1.GB)

## Torque Adjustment

In order to guarantee low-wear clutch operation, it is essential to adjust the torque to a sufficiently high service factor (overload torque to operating torque). Our experience has shown that an adjustment factor of 1,3 to 3 gives good results. For very high load changes, high accelerations and uneven operation, please set the adjustment factor higher.

The respective torque adjustment range is printed on the Adjustment Table (11). Torque adjustment is carried out by turning the adjusting nut (5/20). The installed cup springs (10) are operated in the negative range of the characteristic curve (see Fig. 14). This means that tightening the adjusting nut (5/20) causes the spring force to decrease, and loosening the adjusting nut (5/20) causes the spring force to increase. If no torque is specified on order, the clutch is pre-set to approx. 80 % of the maximum torque. The reference marking and the torque specification show the set value directly. If no changes to the pre-set clutch torque are required customer-side, the hexagon head screws (6/22) must nevertheless be screwed out, painted with Loctite 243 and screwed back in again by the customer.

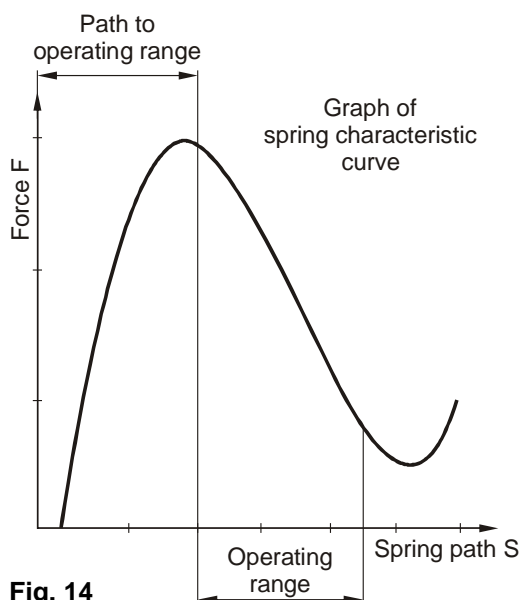

Fig. 14

## Cup Spring Layering

Correct cup spring layering is a prerequisite for problem-free clutch function and torque adjustment. On all Sizes, 7 torque ranges (see Table 3) are possible.

## Changing the Torque

### On clamping ring hub designs Type 48\_\_35\_\_ and Type 48\_\_45\_\_

In order to adjust the torque to a different value, simply

1. loosen and unscrew the hexagon head screw (6),
2. adjust the adjusting nut (5) using a hook wrench until the reference marking shows the required torque value,
3. if necessary, correct the adjusting nut (5) position slightly until the marking notches between the clamping ring hub (1/1.1) and the adjusting nut (5) align, and
4. paint the hexagon head screw (6) with Loctite 243 before screwing it back in again.

### On key design Type 48\_\_25\_\_

In order to adjust the torque to a different value, simply

1. loosen and unscrew the hexagon head screw (22),
2. adjust the adjusting nut (20) using a hook wrench until the reference marking shows the required torque value,
3. if necessary, correct the adjusting nut (20) position slightly until the marking notches between the locking ring (21) and the adjusting nut (20) align, and
4. paint the hexagon head screw (22) with Loctite 243 before screwing it back in again.



Adjusting the adjusting nut (5/20) or distorting the cup springs (10) outside of the cup spring characteristic curve (see Fig. 14) stops the clutch functioning.

Table 3: Cup Spring Layering and Torque Ranges

Type	Cup spring layering <sup>3)</sup>	Size 01		Size 0		Size 1		Size 2		
		[Nm]	Graduation lines for M = 80 %	[Nm]	Graduation lines for M = 80 %	[Nm]	Graduation lines for M = 80 %	[Nm]	Graduation lines for M = 80 %	
48__2__5__	1x1 times	1 \ \ \ \ \ \ \ \ \ \ 7	2,7 – 5	19	5 – 10	21	10 – 20	16	20 – 40	25
48__3__5__	1x2 times	2 \ \ \ \ \ \ \ \ \ \ 6	5 – 10	19	10 – 20	22	20 – 40	17	40 – 80	26
48__4__5__	1x3 times	3 \ \ \ \ \ \ \ \ \ \ 5	8 – 15	20	15 – 30	23	30 – 60	19	60 – 120	28
48__5__5__	1x4 times	4 \ \ \ \ \ \ \ \ \ \ 4	11 – 20	20	20 – 40	23	40 – 80	19	80 – 160	28
48__6__5__	1x6 times	6 \ \ \ \ \ \ \ \ \ \ 2	18 – 33	20	35 – 65	24	70 – 125	20	140 – 250	30
48__7__5__	1x8 times	8 \ \ \ \ \ \ \ \ \ \ 0	32 – 40	21	60 – 80	27	120 – 160	25	240 – 320	32
48__8__5__ <sup>4)</sup>	1x8 times	8 \ \ \ \ \ \ \ \ \ \ 0	35 – 60	24	70 – 120	31	150 – 240	25	300 – 500	35

<sup>3)</sup> **Example:** On Type 481.425.0, the cup spring layering is 1x3 times, which means that three cup springs are engaged thrust washer-side and five cup springs are not engaged (adjusting nut-side) => 3 \ \ \ \ \ \ \ \ \ \ 5.

<sup>4)</sup> Types 48\_\_8\_\_5\_\_ require a special pressure flange as well as a special thrust washer.

# Installation and Operational Instructions for EAS<sup>®</sup>-smartic<sup>®</sup> synchronous clutch Type 48\_.\_5\_.\_ Sizes 01 – 2

(B.4.17.1.GB)

## Changing the Torque Adjustment Range by Changing the Cup Spring Layering

If a customer realises that the selected clutch adjustment range is too high or too low, the cup spring layering (10) on the respective clutch must be changed (every clutch delivered contains a maximum of 8 cup springs).

The adjustment scale on the clamping ring (1.2) or the adjusting nut (20) is no longer applicable after alteration!

Principally, we recommend that modification and re-calibration of the clutch be carried out at the company *mayr*<sup>®</sup> headquarters, where we can provide a higher torque adjustment accuracy than any customer-side alterations.

Changing the cup spring layering (10) between Type 48\_2\_5\_ and Type 48\_7\_5\_ is generally possible.

**If the required torque lies over the torque range of Type 48\_7\_5\_., modification to Type 48\_8\_5\_ is necessary (for modification, a special pressure flange as well as a special thrust washer are necessary) or the next larger construction size must be selected. Types 48\_8\_5\_ have a max. speed of 250 rpm.**

If the required torque lies below the torque range of Type 48\_2\_5\_., the next smaller construction size must be selected. Before changing the cup spring layering (10), the clutch must be removed from the system and placed on a suitable auxiliary shaft, for example in a vice; it must be re-installed with the adjusting nut side facing upwards.

When doing this, the clamping ring (1.2) on the clamping ring design must be re-clamped.

## Changing the cup spring layering and torque adjustment on clamping ring design Type 48\_35\_ and Type 48\_45\_:

1. Turn back the locking screw (6) and remove it from the clamping ring (1.2).  
**Please Observe!** The locking screw (6) is glued into the clamping ring (1.2).
2. Turn the adjusting nut (5) back anti-clockwise until the cup spring package (10) is completely relaxed.
3. Loosen the clamping screw (2) of the clamping ring (1.2) and remove the clamping ring (1.2) from the hub (1).
4. Screw the adjusting nut (5) completely off the hub (1).
5. Change the cup spring layering (10) acc. Table 3.
6. Screw the adjusting nut (5) clockwise onto the hub (1) up to contact on the cup springs (10).
7. Push the clamping ring (1.2) into the correct position (for position of the spring pin (1.3) in the clamping ring (1.2), please see Fig. 15) up to contact on the hub shoulder (1), and tighten the clamping screw (2) to the specified torque (acc. Table 1).
8. Turn the adjusting nut (5) clockwise by the number of graduation lines acc. Table 3. This achieves a torque of approx. 80 % of the maximum value on the respective cup spring layering (10). By turning the adjusting nut (5) clockwise, the clutch torque can be reduced even further. By turning the adjusting nut anti-clockwise, the clutch torque can be increased.  
**The permitted operating range acc. Fig. 14 must be observed.**
9. One of the marking notches on the adjusting nut (5) must be aligned with a notch on the clamping ring (1.2). The locking screw (6) must be painted with Loctite 243 and screwed up to its limit into the clamping ring (1.2).
10. Remove the clutch from the auxiliary shaft and re-install it into the system.

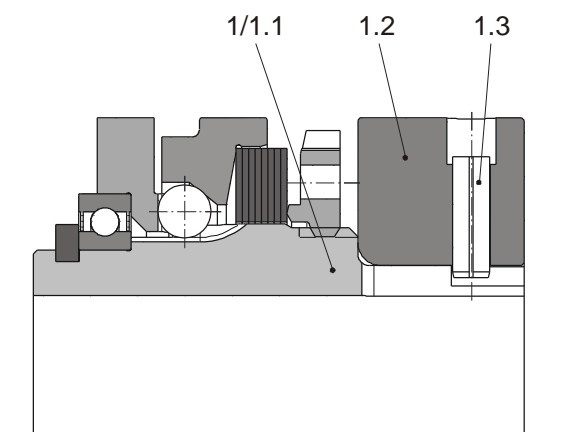

Fig. 15

## Changing the cup spring layering and torque adjustment on key design Type 48\_25\_:

1. Turn back the locking screw (22) and remove it from the adjusting nut (20).  
**Please Observe!** The locking screw (22) is glued into the adjusting nut (20).
2. Turn the adjusting nut (20) back anti-clockwise completely and remove it from the clutch.
3. Remove the locking ring (21) from the hub (19).
4. Change the cup spring layering (10) acc. Table 3.
5. Place the locking ring (21) again up to the cup springs (10) onto the hub (19).
6. Screw the adjusting nut (20) up to contact on the locking ring (21) or up to contact of the locking ring (21) on the cup springs (10) onto the hub (19).
7. Turn the adjusting nut (20) clockwise by the number of graduation lines acc. Table 3. This achieves a torque of approx. 80 % of the maximum value on the respective cup spring layering (10). By turning the adjusting nut (20) clockwise, the clutch torque can be reduced even further. By turning the adjusting nut anti-clockwise, the clutch torque can be increased.  
**The permitted operating range acc. Fig. 14 must be observed.**
8. One of the marking notches on the adjusting nut (20) must be aligned with a notch on the locking ring (21). The locking screw (22) must be painted with Loctite 243 and screwed up to its limit into the adjusting nut (20).
9. Remove the clutch from the auxiliary shaft and re-install it into the system.

# Installation and Operational Instructions for EAS<sup>®</sup>-smartic<sup>®</sup> synchronous clutch Type 48 \_ \_ 5\_ \_ Sizes 01 – 2

(B.4.17.1.GB)

## Limit Switch Installation (Figs. 16 and 17)

The switching direction arrow on the mechanical limit switch housing cover points in the direction of the adjusting nut (5/20) or in the stroke direction of the thrust washer (4).

Adjust the switch distances for the contactless and mechanical limit switch acc. Fig. 16 and Fig. 17.

The distance of the thrust washer (4) to the switching point can be easily adjusted using a hexagon head screw, wrench opening 7.

### Contactless limit switch

#### Undamped installation

Limit switch is damped when clutch disengages.

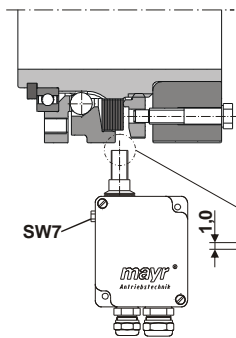

#### Damped installation

Limit switch is not damped when clutch disengages.

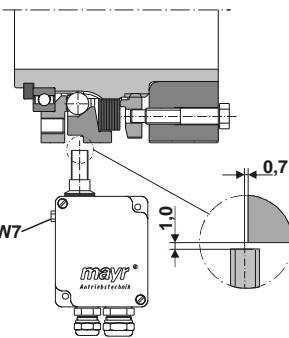

Fig. 16

### Mechanical limit switch (only available on Size 2)

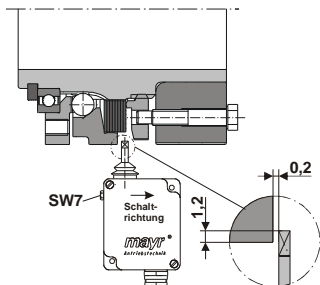

Fig. 17

On EAS<sup>®</sup>-smartic<sup>®</sup> clutches Size 01, we generally recommend the use of smaller, contactless limit switches, e.g. M8 x 1 or similar devices.

## Maintenance

The EAS<sup>®</sup>-smartic<sup>®</sup> clutch is mainly maintenance-free.

The only maintenance work needed is a regular inspection of functionality and torque adjustment => yearly.

Special maintenance work may be necessary should the device be subject to very dirty, dusty or extreme ambient and load conditions. These include:

- Bearing inspection
- Tightening torque inspection
- Lubrication of the transmission geometries, balls, recesses and sealing elements

Under these conditions, it may be necessary to carry out inspections at much shorter intervals.

**We recommend that maintenance work is carried out at the site of manufacture.**

## Disposal

### Electronic Components (Limit switch):

Products which have not been disassembled can be disposed of under Code No. 160214 (mixed materials) or components under Code No. 160216, or can be disposed of by a certified disposal firm.

### All steel components:

Steel scrap (Code No. 160117)

### Aluminium components:

Non-ferrous metals (Code No. 160118)

### Seals, O-rings, V-seals, elastomers:

Plastic (Code No. 160119)

# Installation and Operational Instructions for EAS<sup>®</sup>-smartic<sup>®</sup> synchronous clutch Type 48 \_ \_ 5 \_ Sizes 01 – 2

(B.4.17.1.GB)

## General Malfunctions / Breakdowns

Malfunction	Possible Causes	Solutions
Premature clutch release	Incorrect torque adjustment	<ol style="list-style-type: none"> <li>1) Set the system out of operation</li> <li>2) Check the torque adjustment</li> <li>3) Secure the adjusting nut</li> <li>4) If the cause of malfunction cannot be found, the clutch must be inspected at the place of manufacture</li> </ol>
	Adjusting nut position has changed	
Clutch does not release on overload	Incorrect torque adjustment	<ol style="list-style-type: none"> <li>1) Set the system out of operation</li> <li>2) Check whether foreign bodies influence the clutch function</li> <li>3) Check the torque adjustment</li> <li>4) Secure the adjusting nut</li> <li>5) If the cause of malfunction cannot be found, the clutch must be inspected at the place of manufacture</li> </ol>
	Adjusting nut position has changed	
Running noises in normal operation	Insufficient clutch securement	<ol style="list-style-type: none"> <li>1) Set the system out of operation</li> <li>2) Check the clutch securement</li> <li>3) Check the screw tightening torques</li> <li>4) Check the torque adjustment and that the adjusting nut sits securely</li> <li>5) If the cause of malfunction cannot be found, the clutch must be inspected at the place of manufacture</li> </ol>
	Loosened screws	
	Loosened adjusting nut	



mayr<sup>®</sup> will take no responsibility or guarantee for replacement parts and accessories which have not been delivered by mayr<sup>®</sup>, or for damage resulting from the use of these products.

# Installation and Operational Instructions for EAS<sup>®</sup>-smartic<sup>®</sup> synchronous clutch Type 48 \_\_ 5\_\_ Sizes 01 – 2

(B.4.17.1.GB)

## Malfunctions / Breakdowns Type 484 \_\_ 5\_\_

Malfunction	Possible Causes	Solutions
Changes in running noise and / or vibration occurrence Type 484.	Incorrect alignment	<ol style="list-style-type: none"> <li>1) Set the system out of operation</li> <li>2) Find / resolve the cause of incorrect alignment (e.g. loose foundation screw, broken motor attachment, warmth expansion of system components, changes in coupling installation dimension "E")</li> <li>3) Check the coupling for wear</li> </ol>
	Worn elastomeric element, short-term torque transmission via metal contact	<ol style="list-style-type: none"> <li>1) Set the system out of operation</li> <li>2) Dismantle the coupling and remove the remainders of the elastomeric element</li> <li>3) Check the coupling parts and replace if damaged</li> <li>4) Insert new elastomeric element, mount the coupling parts</li> <li>5) Check the alignment and correct if necessary</li> </ol>
	Tensioning and clamping screws or locking set screw for axial hub securement are loose	<ol style="list-style-type: none"> <li>1) Set the system out of operation</li> <li>2) Check the coupling alignment</li> <li>3) Tighten the tensioning and clamping screws for axial hub securement as well as connection screws to the required torque or tighten the locking set screw and secure it against self-loosening using sealing lacquer</li> <li>4) Check the coupling for wear</li> </ol>
	Loose connection screws	
Cam breakage Type 484.	Worn elastomeric element, torque transmission via metal contact	<ol style="list-style-type: none"> <li>1) Set the system out of operation</li> <li>2) Replace the entire coupling</li> <li>3) Check the alignment</li> </ol>
	Cam breakage due to high impact energy / overloading	<ol style="list-style-type: none"> <li>1) Set the system out of operation</li> <li>2) Replace the entire coupling</li> <li>3) Check the alignment</li> <li>4) Find the cause of overload</li> </ol>
	Operating parameters are not appropriate for the coupling performance	<ol style="list-style-type: none"> <li>1) Set the system out of operation</li> <li>2) Check the operating parameters and select a suitable coupling (observe installation space)</li> <li>3) Install a new coupling</li> <li>4) Check the alignment</li> </ol>
	Operating errors on the system unit by exceeding coupling characteristic data	<ol style="list-style-type: none"> <li>1) Set the system out of operation</li> <li>2) Check the coupling dimensioning</li> <li>3) Replace the entire coupling</li> <li>4) Check the alignment</li> <li>5) Train and advise operating personnel</li> </ol>



mayr<sup>®</sup> will take no responsibility or guarantee for replacement parts and accessories which have not been delivered by mayr<sup>®</sup>, or for damage resulting from the use of these products.



# Installation and Operational Instructions for EAS<sup>®</sup>-smartic<sup>®</sup> synchronous clutch Type 48\_\_5\_\_ Sizes 01 – 2

(B.4.17.1.GB)

## Malfunctions / Breakdowns Type 484\_\_5\_\_ (continued)

Malfunction	Possible Causes	Solutions
Premature wear on the elastomeric element Type 484.	Incorrect alignment	<ol style="list-style-type: none"> <li>1) Set the system out of operation</li> <li>2) Find / resolve the cause of incorrect alignment (e.g. loose foundation screw, broken motor attachment, warmth expansion of system components, changes in coupling installation dimension "E")</li> <li>3) Check the coupling for wear</li> <li>4) Insert new elastomeric element</li> </ol>
	e.g. contact with aggressive fluids / oils, ozone influence, too high ambient temperatures etc., which cause physical changes in the elastomeric element	<ol style="list-style-type: none"> <li>1) Set the system out of operation</li> <li>2) Dismantle the coupling and remove the remainders of the elastomeric element</li> <li>3) Check the coupling parts and replace if damaged</li> <li>4) Insert new elastomeric element, mount the coupling parts</li> <li>5) Check the alignment and correct if necessary</li> <li>6) Make sure that further physical changes in the elastomeric element can be excluded</li> </ol>
	The ambient or contact temperatures permitted for the elastomeric element are exceeded	<ol style="list-style-type: none"> <li>1) Set the system out of operation</li> <li>2) Dismantle the coupling and remove the remainders of the elastomeric element</li> <li>3) Check the ambient or contact temperature and regulate them (possibly using other elastomeric element materials)</li> <li>4) Check the coupling parts and replace if damaged</li> <li>5) Insert new elastomeric element, mount the coupling parts</li> <li>6) Check the alignment and correct if necessary</li> </ol>
Premature wear on the elastomeric element (material liquefaction in the elastomeric element tooth interior) Type 484.	Drive vibrations	<ol style="list-style-type: none"> <li>1) Set the system out of operation</li> <li>2) Dismantle the coupling and remove the remainders of the elastomeric element</li> <li>3) Determine the cause of vibration (maybe the problem can be resolved by using an elastomeric element with lower or higher shore hardness)</li> <li>4) Check the coupling parts and replace if damaged</li> <li>5) Insert new elastomeric element, mount the coupling parts</li> <li>6) Check the alignment and correct if necessary</li> </ol>



mayr<sup>®</sup> will take no responsibility or guarantee for replacement parts and accessories which have not been delivered by mayr<sup>®</sup>, or for damage resulting from the use of these products.

# Installation and Operational Instructions for EAS<sup>®</sup>-smartic<sup>®</sup> synchronous clutch Type 48 \_\_ 5\_\_ Sizes 01 – 2

(B.4.17.1.GB)

## Malfunctions / Breakdowns Type 486\_\_ 5\_\_

Malfunction	Possible Causes	Solutions
Changes in running noise and / or vibration occurrence Type 486.	Incorrect alignment, incorrect installation	<ol style="list-style-type: none"> <li>0) Set the system out of operation</li> <li>1) Find and remove the cause of incorrect alignment</li> <li>2) Check the coupling for wear</li> </ol>
	Loose connecting screws, minor friction corrosion under the screw head and on the disk pack	<ol style="list-style-type: none"> <li>1) Set the system out of operation</li> <li>2) Check the coupling parts and replace if damaged</li> <li>3) Tighten the connecting screws to the specified torque</li> <li>4) Check the alignment and correct if necessary</li> </ol>
	Tensioning screws or locking set screw for axial securement of the hubs are loose	<ol style="list-style-type: none"> <li>1) Set the system out of operation</li> <li>2) Check the coupling alignment</li> <li>3) Tighten the tensioning and clamping screws for axial hub securement to the required torque or tighten the locking set screw and secure it against self-loosening using sealing lacquer</li> <li>4) Check the coupling for wear</li> </ol>
Disk pack breakage Type 486.	Disk pack breakage due to high load impacts / overload	<ol style="list-style-type: none"> <li>1) Set the system out of operation</li> <li>2) Dismantle the coupling and remove the remainders of the disk packs</li> <li>3) Check the coupling parts and replace if damaged</li> <li>4) Find the cause of overload and remove it</li> </ol>
	Operating parameters are not appropriate for the coupling performance	<ol style="list-style-type: none"> <li>1) Set the system out of operation</li> <li>2) Check the operating parameters and select a suitable coupling (observe installation space)</li> <li>3) Install a new coupling</li> <li>4) Check the alignment</li> </ol>
	Incorrect operation of the system unit	<ol style="list-style-type: none"> <li>1) Set the system out of operation</li> <li>2) Dismantle the coupling and remove the remainders of the disk packs</li> <li>3) Check the coupling parts and replace if damaged</li> <li>4) Train and advise operating personnel</li> </ol>
Disk pack / connecting screw cracks or breakage Type 486.	Drive vibrations	<ol style="list-style-type: none"> <li>1) Set the system out of operation</li> <li>2) Dismantle the coupling and remove the remainders of the disk packs</li> <li>3) Check the coupling parts and replace if damaged</li> <li>4) Check the alignment and correct if necessary</li> <li>5) Find the cause of vibration and remove it</li> </ol>



mayr<sup>®</sup> will take no responsibility or guarantee for replacement parts and accessories which have not been delivered by mayr<sup>®</sup>, or for damage resulting from the use of these products.